



---

Responsible Dept.: Global Supply Chain

NOTE: Any printed copy of this document is an uncontrolled copy. The user must check the controlled version located in the Global Document Control Lotus Notes database, under the procedure MKS-CSC-1125.

---

# MKS<sup>®</sup> Products Workmanship Standards Cable and Wire Standards

*The controlled standard resides in the Global Document Control Lotus Notes database under the procedure MKS-CSC-1125. All printed copies are considered uncontrolled, and it is the responsibility of the person(s) using the hard copy to verify that it is current with the controlled version.*



## TABLE OF CONTENTS

**INTRODUCTION AND SCOPE** ..... 3

**CHAPTER 1: CABLES, WIRES, AND ASSOCIATED ASSEMBLIES** ..... 6

1. GENERAL & ACCEPTANCE CRITERIA ..... 7

2. LABELING ..... 7

*Terminals & Connectors* ..... 8

*Wire Markers* ..... 8

*Indication of completed testing* ..... 9

3. CABLE PREPARATION - COAXIAL CABLE ..... 10

4. RIGHT ANGLE CONNECTORS ..... 10

5. WIRE TWIST ..... 12

6. SHRINK SLEEVING ..... 14

7. CABLE TIES ..... 14

8. FIBER OPTIC CABLES ..... 14

9. ADDITIONAL ACCEPTANCE CRITERIA ..... 15

10. TESTING REQUIREMENTS ..... 15

**CHAPTER 2: SOLDERING REQUIREMENTS**..... 16

1. SCOPE: ..... 16

2. HAND SOLDERING EQUIPMENT: ..... 16

3. TEMPERATURE SETTINGS: ..... 16

4. SOLDER: ..... 16

5. PARTS TINNING: ..... 17

**CHAPTER 3: PACKAGING REQUIREMENTS**..... 18

1. GENERAL PACKAGING REQUIREMENTS ..... 19

2. CARDBOARD BOXES ..... 20

3. BUBBLE WRAP ..... 20

4. PEM NUTS/STUDS/HARDWARE (AS APPLICABLE) ..... 21

5. PART SEPERATION ..... 22

6. REUSABLE PACKAGING ..... 22

7. PART AND PACKAGING CLEANLINESS ..... 22

# ***Introduction and Scope***

This Workmanship Standard publication serves as a guideline and acceptance criteria for cables, wires, and associated assemblies manufactured and/or purchased by MKS® Products.

**In addition to the requirements specified in this document, MKS-designed parts shall be compliant to the current revisions of the following industry standards as applicable, unless specific requirements are superseded by MKS requirements:**

IPC-620 - Requirements and Acceptance for Cable and Wire Harness Assemblies

IPC J-STD-001 - Requirements for Soldered Electrical and Electronic Assemblies

IPC-7711/7721 - Rework, Modification and Repair of Electronic Assemblies. **Note: this only applies to those cable assemblies which contain, or are attached to, PCBA's**

In the event of conflict between documentation, the order of precedence will be:

1. Purchase orders as agreed to between MKS and supplier
2. Engineering drawings
3. Process details and work instructions
4. MKS Workmanship Standards
5. Other applicable accepted standards (e.g. IPC-610 and IPC-620) **Note that IPC-610 would only apply to those cable assemblies which contain, or are attached to, PCBA's**

*This Workmanship Standard SUPERCEDES and REPLACES any reference to the following documents:*

- ENI Workmanship Standard (as related to cable and cable assemblies)
- Astex Workmanship Standards (as related to cable and cable assemblies)
- Granville Philips Workmanship Manual (as related to cable and cable assemblies)



## General Requirements

### MKS Acceptance Criteria for all classes of parts:

1. Shipping packaging shall be labeled with the following information:
  - a. Purchase Order number
  - b. Vendor identification
  - c. MKS part number
  - d. Manufacturer's name
  - e. Manufacturer's part number
  - f. Revision of part (where applicable)
  - g. Country of Origin
  - h. Marked, labeled, or stamped if C of C is enclosed, where applicable
  - i. Any additional labeling as required by the drawing
  - j. In cases where a shipment consists of more than one container, each container shall be marked/labeled on the outside identifying it as one of a series.
  
2. Part Packaging – MKS design-controlled
  - a. All packaging material must be compatible with the parts that they protect and must not chemically interact with them, causing damage to the parts.
  - b. Individual part package procedures shall be followed based on MKS drawings and/or PO instructions if applicable.
  - c. If drawing notes are not specific, minimum protective packaging on each part or group of parts shall be marked with:
    1. Vendor identification
    2. MKS part number
    3. Revision level
    4. Date Code or Serial Number (where applicable)
  
3. For non-MKS designed parts (“commercial” parts), minimum protective packaging shall be marked with:
  - a. Vendor identification
  - b. MKS part number
  - c. Manufacturer's name
  - d. Manufacturer's part number
  - e. Revision (where applicable)
  - f. Date/Lot Code, or Serial Number (where applicable)

## SPECIAL HANDLING PROCEDURES:

1. **Parts Handling and Storage:** Special care is required when handling, transporting, or storing parts and assemblies. Painted, silk-screened, or iridited surfaces must be protected from scratches and dents during storage and assembly. Metal parts should be wrapped in static safe or anti-static materials or be separated (by special fixtures) when stored on material racks. **(Note: paper or static-generating material must be discarded prior to assembly introduction of electronic components.** With all parts, stacking should be minimized and done for metal parts only where their surfaces are protected.
2. **ESD Practices:** All electronic parts and assemblies subject to ESD damage should be handled in accordance with proper ESD practices as specified in MKS/ENI Global Work Instruction QMS-GWI-0009 (internal MKS use only), or ANSI/EIA 625 and EIA 541. **Note: this only applies to those cable assemblies which contain or are attached to PCBA's**

## REWORK AND REPAIR:

### Definitions:

**REWORK:** Rework is bringing the defective part, material, or assembly back into "AS NEW" condition using generally accepted industry practices.

**REPAIR:** Repair is fixing the defective part, material, or assembly so that it works, but it **does not meet the original drawing or process detail to which it was** built (e.g.: inserting helicoils, etc). Repairs that do not meet all requirements of the MKS design documentation and purchase orders must be authorized by MKS prior to the repair being performed.

### Requirements:

MKS allows manufacturers to rework material in accordance with generally accepted processes and/or specific MKS requirements, unless specifically forbidden. **Repairing of material such that it does not meet the MKS drawing or process detail, or reworking of material using processes forbidden by MKS drawing, specification, or process detail, is not allowed without prior authorization via formal deviation or equivalent.**



# ***Chapter 1: Cables, Wires, and Associated Assemblies***

The following pages contain information and guidelines for the accepted Workmanship Standards for cables, wires, and other related items. Any notes or specifications on a part drawing will take precedence over these standards.

## 1. GENERAL & ACCEPTANCE CRITERIA

Unless otherwise specified, IPC-A-620 **Class 2** (latest revision) requirements shall apply to all cable assemblies and related parts/assemblies.

- a) Care should be taken to avoid wire or insulation damage. *Wire should be stripped as evenly as possible.*
- b) Any insulation that is removed should be stripped using thermal, chemical, or precision cutting-type strippers. Knives or pliers should not be used.
- c) Lead wire with isolation ratings equal to, or excess of, 6 KV that have nicks, marks, cuts, chips, scratches, or any other type of defect or imperfection after stripping are unacceptable.
- d) Unless otherwise specified, all hardware (connectors, terminals, etc) shall be installed per manufacturer's recommendations.
- e) Unless otherwise specified, all hardware (connectors, terminals, etc) shall be installed using the equipment specified (recommended) by the applicable hardware manufacturer. **Deviations from this requirement require MKS approval prior to implementation and FAI submission, and also require qualification documentation showing conformance to UL/CSA requirements be submitted to MKS.**

## 2. LABELING

**Note: If UL recognition is required, all applicable UL labeling and traceability requirements must be met in addition to the labeling requirements listed below.**

### **Cable Assemblies & other terminated connections**

If the drawing references a note such as "For Labeling Instructions, Refer to the ENI Workmanship Standards" or "MKS Engineering Process EP0501", "Mark Part per MKS Spec. SR00007 approximately Where Shown", or any other divisional workmanship standard, and does not call out specific labeling requirements, the following applies:

#### **i) Identification**

Each cable or harness shall be identified with an identification label per the following:

- (1) Unless otherwise specified on the Bill of Materials, label stock (MKS part number) 751017 or equivalent shall be used.
- (2) All labels shall be printed or typed, not hand-written. Refer to latest IPC/WHMA-A-620 specification.
- (3) Each label shall be of sufficient length to wrap around the cable completely and stick to itself.
- (4) The label shall provide the following information:

- (a) Bill of Materials number and revision
- (b) MKS Vendor identification number or name
- (c) Date Code (if space allows on label)

If a label cannot be used due to size constraints, each cable assembly or harness group at minimum shall be identified with an identification label placed on the packaging of each assembly and harness group. The label shall provide the following information:

- (1) Bill of Materials number and revision
- (2) MKS Vendor identification number or name
- (3) Date Code

ii) **Placement**

Unless otherwise specified on the drawing the placement of the label will be per the chart below:

Type	Length	Qty.	Placement of Label
Cable	< 900mm	1	~ Center of Cable
	> 900mm	2	One at each end of the cable and located as close as possible to the end of the cable jacket (approx. 1 inch).
Harness	< 900mm	1	One at approximately 1" from end of the main connector.
	> 900mm	2	One at approx. 1" from end of the main connector and one at approx. 1" from opposite end of any branch > 900mm in length.

**Terminals & Connectors**

When component reference designations are specified, each terminal OR connector end shall be marked with its component reference designation (e.g. P1, J2), unless otherwise specified. This applies to cables, wires, and other wire termination as part of an electro-mechanical assembly.

**Wire Markers**

Any individual wire shall be marked with its reference designation (e.g. W1, W2, E1, L1, etc.) if the reference designator is specified on the drawing. Placement of the marker will be in the center of the wire, unless otherwise specified.





Exceptions: Unless otherwise specified, wires do NOT require markers if the following applies:

- (1) Wires that have “**BOTH**” ends of the wire terminated into a multi-position connector (in which case the *connectors* are to be marked with their reference designation if specified per above).
- (2) Wires that are terminated at one end into a multi-position connector and the other end of the wires are terminated with free terminals such as fastons or ring lugs.

### **Indication of completed testing**

All individual cables, wires, and related assemblies shall have an indication that all required testing has been completed. If not specifically callout out on the MKS drawing, specification, process detail, or purchase order, methods such as marker dotting, labeling indicating acceptance, etc may be used to indicate all required testing has been completed for each wire, cable, and related assembly. Supplier is to provide information to MKS on the indication method used to meet this requirement during FAI submission.

### 3. CABLE PREPARATION - COAXIAL CABLE

- a) Added care is needed when stripping the outer insulation to not damage the shield or coaxial insulation. **USE PROPER COAX STRIPPING TOOLS.** No damage is permitted.
- b) When required, the shield will be separated into a ground conductor by using a lead extractor tool. "Combing" the shield into individual strands will be permitted only if specified by the process sheet.
- c) Only the tip of the shield should be tinned. The shield should remain flexible.
- d) The use of a Ty-wrap gun on Coaxial Cables is prohibited. Hand-tighten Ty-wraps until they are snug against the cable and trim using wire cutters.

### 4. RIGHT ANGLE CONNECTORS

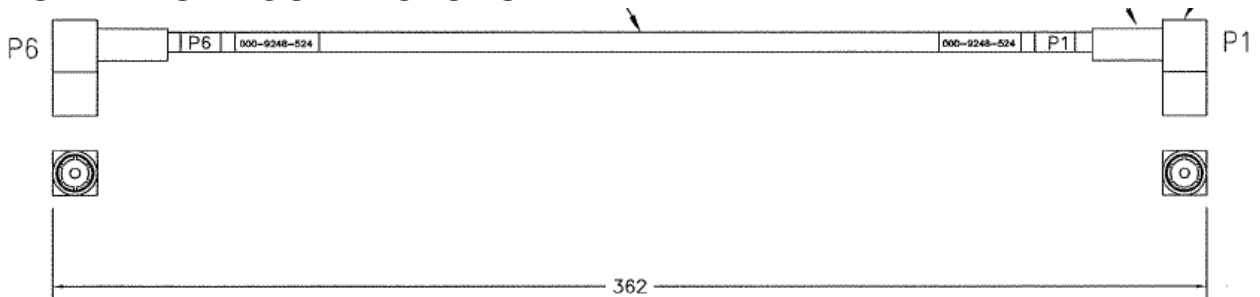

#### Example

For coaxial cable assemblies with right angle RF connectors at each end (such as RA SMB to RA SMB) or RF connectors with keying features, in order to minimize twisting the coaxial cable to achieve the orientation illustrated on the drawing the connectors must be oriented so that the included angle between connectors or keying feature at either end of the cable assembly or branch does not exceed 2 degrees per inch [25mm] of length between the connectors, unless otherwise specified.

### Acceptance Criteria

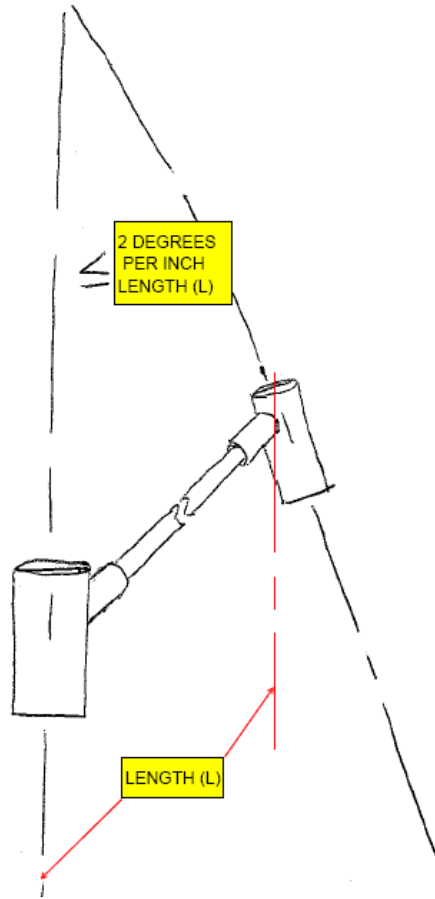

**Acceptance Criteria (continued)**

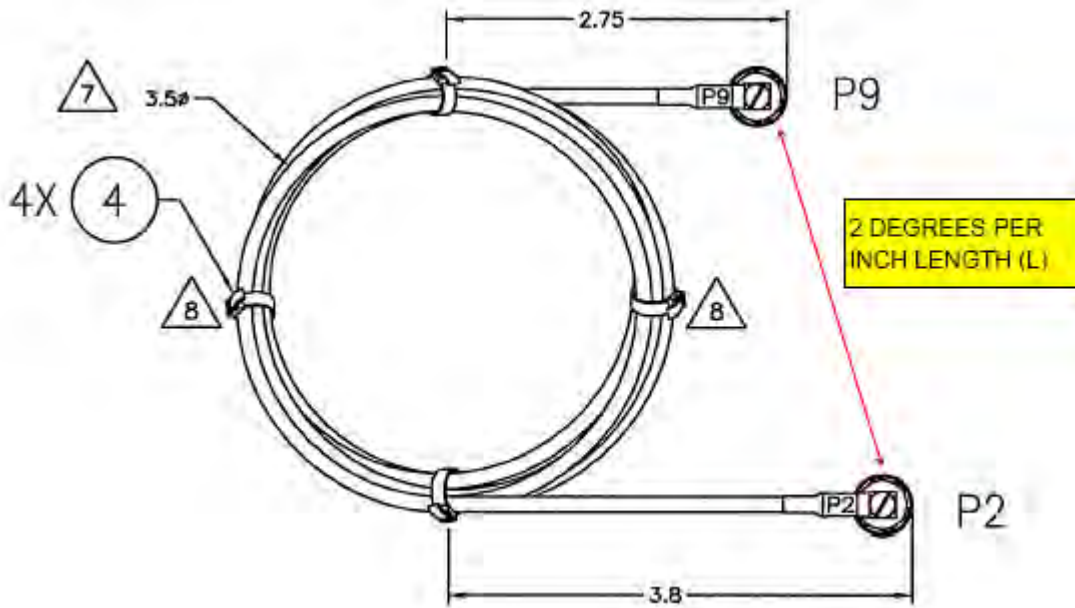

**5. WIRE TWIST**

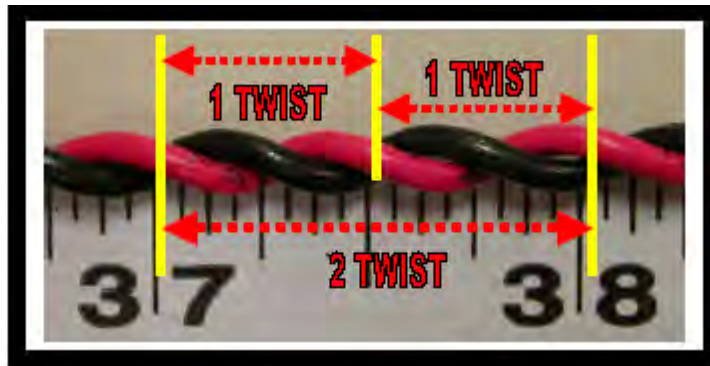

**ONE COLOR WIRE TWIST**

1. Take one wire from the top of the turn, and every time the same wire reaches the top again, that is one twist.

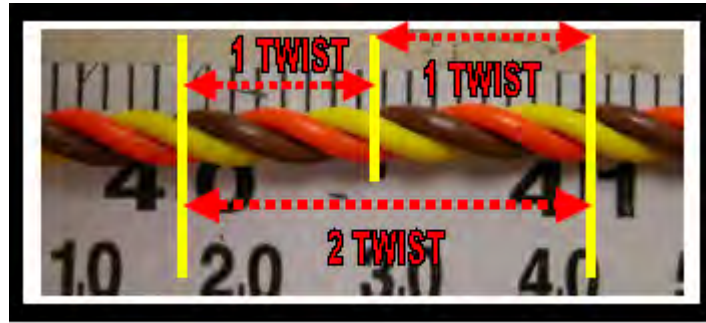

**THREE COLOR WIRE TWIST**

2. Here is an example of a three-color wire twist, but still two-twists per inch.

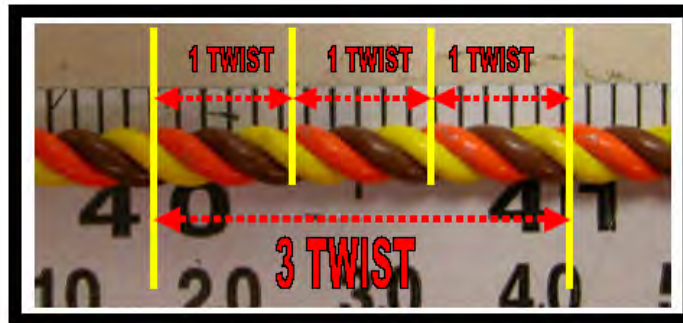

**THREE COLOR WIRE TWIST**

3. This is three-color wire with three-twists per inch.



**MULTI-COLOR WIRE TWIST**

4. This is multi-colored wire twist, with one twist per inch.

## Wire Twist Tolerance

When a cable or harness assembly drawing specifies a twist rate for wire used in that assembly and no tolerance or range is given for the twist rate, assume a tolerance of  $\pm 1/4$  twist for each specified twist per inch or twist per 25 mm. For instance, if the specification is 1 twist per inch assume the tolerance is  $\pm 1/4$  twist so the implied specification is 1  $\pm 1/4$  twist per inch. If the specification is 2 twists per 25mm the tolerance will be  $\pm 1/2$  twist so the implied specification is 2  $\pm 1/2$  twist per 25 mm.

## 6. SHRINK SLEEVING

- a) Unless otherwise specified, shrink all sleeving completely.
- B) All sleeving shall be located per reference drawing. If dimension is not specified, then sleeving shall be centrally located on wires. If sleeving length is not specified on the drawing, use length specified on the BOM.

## 7. CABLE TIES

- a) Unless specifically dimensioned on the drawing all cable ties shall be equally spaced along the length of the cable as shown. The first and last cable tie will be located a minimum distance of 1" from the cable tie to the near edge of the connector. Minimum location length from a breakout shall be per IPC/WHMA-A-620.

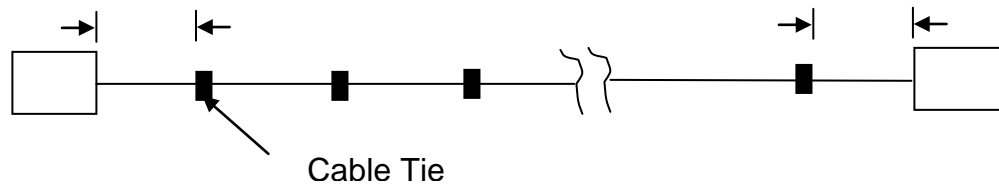

## 8. FIBER OPTIC CABLES

- a) Care should be taken to avoid fiber strands or insulation damage.
- b) Simplex connector crimp rings (single type connectors) are the only crimp that should be used. Simplex crimp rings have a dull silver luster where a duplex will be glossy with a thinner wall.
- c) Unless otherwise noted on the Assembly Drawing or Process Detail, cut, strip, assemble and polish per manufacturer's recommendation.
- d) Fiber optic cables are fragile to bends. Care needs to be taken during handling and packaging to avoid critical radius bends as identified in the drawing or manufacturer specification.
- e) **Inspection Criteria:**
  - i) No nicks or defects in cable outer jacket.
  - ii) No nicks or defects in stripped end prior to assembly.
  - iii) Crimp ring should be crimped tight and closer to the rear end of the connector.

- iv) There should be no cracks on the connector body.
- v) The flush end of the connector with the cable should be clean, smooth and flat.
- vi) Point one end of the cable assembly close to a light source; view the opposite end under 7x magnification. There should be no visual defects (black marks or defusing). There should be bright light transmission.
- vii) Repeat this process with the opposite side of the connector.
- f) The use of a Ty-wrap gun on Fiber Optic Cables is **PROHIBITED**. Hand-tighten Ty-wraps until they are snug against the cable and trim using wire cutters.

## 9. ADDITIONAL ACCEPTANCE CRITERIA

For acceptance criteria specific to all other types of wire or cable and terminations, see the current revision of IPC-620.

## 10. TESTING REQUIREMENTS

For testing requirements not defined on MKS drawings or specifications, refer to the applicable section of the current revision of IPC-620

## ***Chapter 2: Soldering Requirements***

### **1. SCOPE:**

The soldering requirements presented below are applicable only for soldered on fittings, connectors, or other components.

### **2. HAND SOLDERING EQUIPMENT:**

Solder stations must be temperature regulated and not generate an electrostatic charge at the tip or surface. It is also required that all solder stations will be calibrated on a regular schedule. A preventative maintenance plan for solder stations should also be implemented.

For soldering materials or parts not affected by temperature or ESD, a non-temperature controlled solder iron may be used provided it has a three-prong grounded power plug to ensure the iron is grounded for safety purposes.

### **3. TEMPERATURE SETTINGS:**

Due to the wide range of soldering done, solder stations should be set at the lowest temperature to accomplish proper solder joint criteria.

**Exceptions:** For temperature sensitive devices Process Details, Assembly Drawings or instructions will specify temperature settings and special assembly requirements.

### **4. SOLDER:**

There are two types of wire solder used, regular and high temperature. High temperature solder is used where high current or temperatures may be encountered. Where high temperature solder is required, it will be specified in Process Details, drawings, product specification, PCBA assembly drawing and/or the Bill of Materials. Regular solder should be used in all non-specified soldering applications.



## 5. PARTS TINNING:

**THE FOLLOWING SOLDER POTS MAY BE USED FOR TINNING AS NOTED:**

- 1) **SN95 (SnAg5.0) OR SN96.5 (SnAg3.5) FOR ROHS COMPLIANT AND STANDARD USE PER J-STD-006**
- 2) **SN95 (SnAg5.0) PER J-STD-006 FOR GOLD LEADED TRANSISTOR TINNING ONLY!**
- 3) **FOR LEGACY PRODUCT ALLOWING THE USE OF LEADED SOLDER (PRODUCT PREVIOUSLY QUALIFIED AND APPROVED BY MKS), SN63 MAY BE USED.**

It is required that gold leaded components be tinned prior to installation. Gold leaded components (i.e. power transistors) will be tinned with high-temperature solder, SN 95 and each lead double dipped. Solder pots for tinning are designated as high-temperature or standard pots as listed in Item 1. When specified in an Assembly Drawing, Process Details or special assembly instructions, non-gold leaded components and wire should be tinned with solder as listed in Item 1 unless otherwise noted.

**Note:** Although tinning other standard components (non-gold leaded) is not a requirement, tinning can and should be done to components that are difficult to solder or appear to have mild surface corrosion.

Unless otherwise specified, **stranded** wire shall be tinned using solder conforming to J-STD-006 and the soldering will be compliant to J-STD-001. Stranded wire tinning should be performed per manufacturer's recommendations or industry best practices.

**Exceptions:** Wires that are intended to be secured in threaded fasteners or crimped terminations **shall never** be tinned, unless this requirement is identified on the MKS drawing, specification, or process detail.

Solder pots are required to be part of the preventive maintenance program with a defined schedule for refreshing the solder to ensure the solder is maintained and contaminants are not introduced.

## ***Chapter 3: Packaging Requirements***

*Note: The packaging requirements listed on the following pages are a general overview of the MKS packaging requirements and are not specific to the cable / wire harness commodity. They provide guidance on the expectation of MKS in regards to packaging. Supplier retains the requirement to develop and supply packaging to ensure components and assemblies arrive at MKS properly labeled and undamaged.*

# Introduction

- Please note, all pictures contained in this section are merely a representation of proper packaging techniques. Individual packaging designs must be optimized for each application.
- With the overall sensitivity of our customer to cosmetic defects (i.e.) scratches, gouges, shadowing, etc. ever increasing, it has been necessary to standardize all packaging
- Without compromising safety to the individual, the primary goal of our supplier packaging is to provide damage-free delivery of the product from its point of manufacture and origin to its point of delivery, use, and installation under normal handling and transportation conditions.

## 1. GENERAL PACKAGING REQUIREMENTS

- Same parts must be packaged consistently from shipment to shipment, both in the containers used and quantity of parts per container for a given part number.
- Multiple parts that make one part number must be identified as one set or one unit and must be consolidated to prevent separation.
- Protect all bubble-wrapped parts from punctures, abrasions, and protrusions, which could lead to personal injury, part damage, and part contamination during the handling and distribution cycle. All studs must be capped and all sharp corners and edges protected to prevent damage to personnel and/or other parts.
- The use of staples and rubber bands is prohibited in individual part packaging.
- Parts must be adequately separated to prevent damage to one another.
- Parts must be packed to prevent part shifting/rubbing.
- Packaging must not adhere to parts in such a manner that it is difficult to remove and/or leaves residue on the part.
- Packaging must not produce part corrosion or oxidation.
- Packages should not be filled to the extent that they bulge.
- Voids should be filled as required to prevent part shifting or movement within the package. Use of loose-filled dunnage is prohibited (i.e.) peanuts, popcorn, etc.
- All wood packaging must be consistent with the International Plant Protection Convention standard ISPM# 15.

- All containers must be properly labeled with the correct part number, quantity, date of manufacture, date of shipment, and source.

## 2. CARDBOARD BOXES

- All cardboard boxes must be at least 2-ply at a minimum. Anything less will not be acceptable.
- The purpose of the cardboard containers is to contain, handle, transport, and store the product in a safe, defect-free condition until point of usage.
- It is the supplier's responsibility to understand the logistics of their product and to package accordingly to ensure damage-free delivery.



## 3. BUBBLE WRAP

- The purpose of the bubble wrap is to protect the individual parts within a container from being damaged.
- Prematurely discarding of the bubble wrap can result in contamination or handling damage to the part(s), it must be folded and taped with poly (plastic) tape.
- Completely wrap individual units in bubble wrap only. Units must be completely wrapped before they are packed. Tissue paper will no longer be accepted.
- Protect all bubble-wrapped parts from punctures, abrasions, and protrusions, which could lead to personal injury, part damage, and part contamination during the handling and distribution cycle. All studs and sharp corners and edges must be protected to prevent damage to personnel and/or other parts.



#### 4. PEM NUTS/STUDS/HARDWARE (AS APPLICABLE)

- Ensure that all PEM nuts, studs, and other hardware are completely covered with bubble wrap, and are protected in a way that will not cosmetically damage another part in the same pack. It has become a reoccurring issue that parts are damaged because the hardware are not properly protected.
- All studs, sharp corners and edges must be protected to prevent damage to personnel and/or other parts.

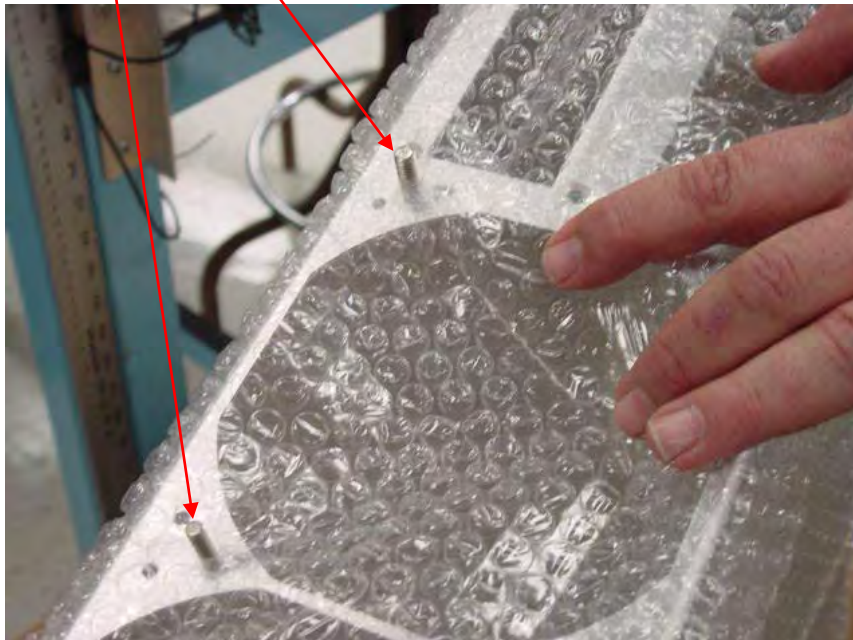

## 5. PART SEPERATION

- Parts must be adequately separated to prevent damaging one another.

## 6. REUSABLE PACKAGING

- Reusable containers are used to facilitate the shipment of product from one facility to another and will then be returned to the original shipper or a third party.
- All reusable containers shall consider factors which will make the container easy to use, durable, and quick to identify.
- All reusable containers should include the following: label identifying it as a reusable container, owner of the reusable container, and the return address for the reusable container. All markings and labels should be highly visible and legible.
- Prior to reuse all reusable containers should be refurbished to a like-new condition.

## 7. PART AND PACKAGING CLEANLINESS

- It is the supplier's responsibility to first understand the required part cleanliness prior to defining the cleanliness of the packaging to utilize for that part.
- Unless the part cleaning requirements are otherwise stated in a contract, purchase order, drawing, or separate specification, the part should be, at a minimum, free of any visible contaminates (visibly clean), including, but not limited to, dust, corrosion, films, and shavings.

Visibly clean packaging, like visibly clean parts, must at a minimum be free of visible contaminates as described above. The packaging should never degrade the cleanliness level of the part.